

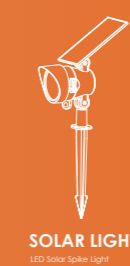

2026 CATALOGUE

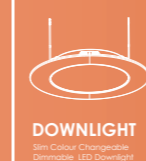

Factory Add: No.255 Yindong South Rd., Yinzhou Economic Development Zone,
Zhanqi Town, Ningbo City, Zhejiang, China.

Email: manager@silanglighting.com

Website: www.silanglighting.com

Tel: (+86)-574-55003160 (+86)-18058563635

North America



e-Catalogue

COMPANY PROFILE



20000 m²
Plant area

200+
Workers

30 +
Export country

\$40 million
Annual output



Ningbo SILANG Lighting is a professional LED lighting manufacturer focused on designing, producing, and developing high-quality LED products. With years of experience, we help upgrade indoor and outdoor lighting with reliable downlights, floodlights, smart lights, and solar lights.

Based in Ningbo—just 30 minutes from Ningbo Port—we offer fast delivery and a strong supply chain. Our products are easy to use, innovative, and trusted by customers across Europe, Australia, New Zealand, and the US.

We continuously invest in R&D and work closely with our clients to bring new ideas to life. No matter what your project involves, we're here to provide lighting solutions that support your goals.









CERTIFICATION



OUR STRENGTH

- 
Competitive Pricing & Quality Products: We design and produce professional LED lights in our own lab and factory, using self-developed drivers and advanced equipment. This allows us to offer high-quality lighting at reasonable prices with flexible order quantities.
- 
Rigorous Quality Control: With over 10 years in LED lighting, we follow ISO9001 standards and meet CE, ETL, and RCM certifications. Our strict QC process includes incoming checks, assembly inspections, and pre-shipment full inspections upon request.
- 
Stable & Fast Delivery: With 200+ skilled workers and 22 production lines, we output 600,000 pieces monthly. Being located just 30 minutes from Ningbo Port ensures smooth and efficient exports.
- 
Strong R&D & Customization: Our dedicated R&D team launches 6+ new products each year. We also provide deep customization based on feedback from European, Australian, and American markets.
- 
Global Production Bases: We operate factories in both China and Vietnam, which ensures stable supply and competitive cost advantages.

FACILITY

Downlight



Security Light



Commercial Light



Work Light



US

Code DL-SG260-212D3
 Wattage 12W
 CCT(K) 2700K/3000K/4000K/5000K/6500K
 Lumen 1050lm
 Beam Angle 100°
 Dimmable Yes(Triac)
 Material Nylon+Al+PC
 Height 30mm



29mm Super Thin Design
 Suitable for various cans

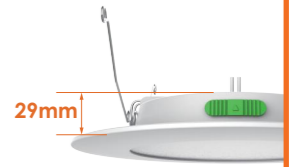

Adjustable Spring
 Fit in 5"/6" can housing

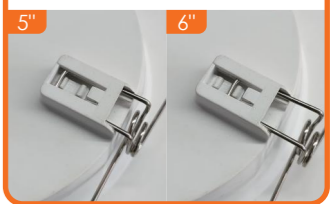

Easy to Install
 Hook, push, and done

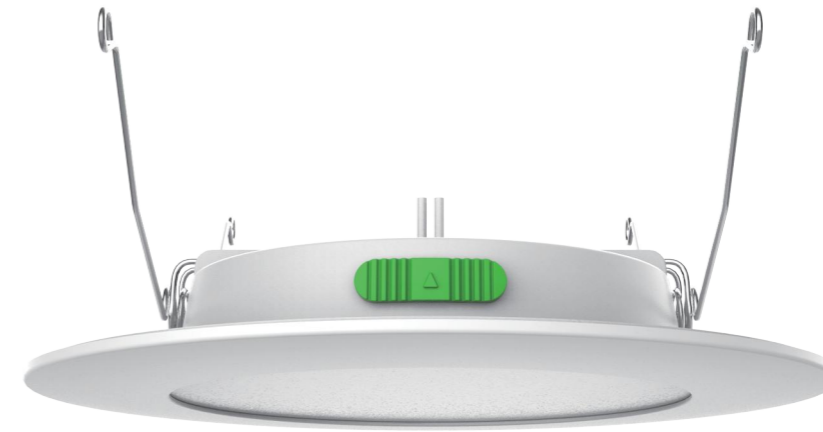

SG series White Black

5"/6" 5CCT LED Can Light

SG Series				
Code	DL-SG260-212D3	DL-SG360-212D3	DL-SG260-212D5	DL-SG360-212D5
Wattage	12W	12W	12W	12W
Lumen	1050lm	960lm	1050lm	960lm
Beam Angle	110°	110°	110°	110°
Cutout	5-6inch	5-6inch	5-6inch	5-6inch
Height	30mm	28.5mm	30mm	28.5mm





Code WL-YD2R-234P
 Wattage 30W
 CCT(K) 3000K/4000K/6500K
 Lumen 3200lm
 Beam Angle 85°/head
 Working Mode Auto/D2D/On time
 Detection Brightness 5-2000Lux
 Detection Range 150°,12m max
 Material PC



Photocell/Motion Sensor
 Wide applications in various space



Multiple Working Modes
 AUTO/D2D/ON TIME modes available



Optional Control Methods
 Remote/App control available



YDR series



3CCT Outdoor LED Security Light

YDR Series				
Code	SL-YDR03-230D8	WL-YDR-230P-D5	WL-YDR-230P-D4	WL-YD2R-230P
Wattage	30W			
Lumen	3200lm			
Working Mode	D2D/On time	Auto/On time	Auto/D2D/On time	Auto/D2D/On time
Detection Range	/	120°/12m max	120°/12m max	150°/12m max



Code WL-YD2S-240P
 Wattage 40W
 CCT(K) 3000K/4000K/6500K
 Lumen 4000lm
 Beam Angle 100°/head
 Working Mode Auto/D2D/On time
 Detection Brightness 5-2000Lux
 Detection Range 150°,10-12m max
 Material PC+Glass



Photocell/Motion Sensor
 Wide applications in various space



Multiple Working Modes
 AUTO/D2D/ON TIME modes available



Optional Control Methods
 Remote/App control available



YDS series



3CCT Outdoor LED Security Light

YDS Series				
Code	WL-YDS03-240D8	WL-YDS-240P-D5	WL-YDS-240P-D4	WL-YD2S-240P
Wattage	40W			
Lumen	4000lm(BK)/4400lm(WH)			
Working Mode	D2D/On time	Auto/On time	Auto/D2D/On time	Auto/D2D/On time
Detection Range	/	120°/12m max	120°/12m max	150°/12m max





SECURITY LIGHT

Code WL-YES-260P
Wattage 60W
CCT(K) 3000K/4000K/6000K
Lumen 6000lm
Beam Angle 100°/head
Working Mode Auto/D2D/On time
Detection Brightness 5-2000Lux
Detection Range 150°, 12m max
Material AL+PC



Heat Dissipation Design

Longer service life & more durable



Photocell/Motion Sensor

Wide applications in various space



Multiple Working Modes

AUTO/D2D/ON TIME modes available



YES(R) series



3CCT Round/Square LED Security Light



SECURITY LIGHT

Code WL-YEL-242P
Wattage 42W
CCT(K) 3000K/4000K/5000K/5700K/6500K
Lumen 4000lm
Beam Angle 85°/head
Detection Range 180°, 21m max
Material PC+Glass



Photocell/Motion Sensor

Wide applications in various space



Multiple Working Modes

Connect the lights for AUTO/D2D/ON TIME modes available



Optional Control Methods

Remote/App control available



YEL series



5CCT Outdoor LED Security Light

YER Series			<small>New</small>			<small>New</small>
Code	WL-YER03-230D8	WL-YER-230P-D4	WL-YER-230P	WL-YES03-260D8	WL-YES-260P-D4	WL-YES-260P
Wattage	30W	30W	30W	60W	60W	60W
Lumen	2400lm	2400lm	2400lm	6000lm	6000lm	6000lm
Working Mode	D2D/On time	Auto/D2D/On time	Auto/D2D/On time	D2D/On time	Auto/D2D/On time	Auto/D2D/On time
Detection Range	/	120°/12m max	150°/12m max	/	120°/12m max	150°/12m max

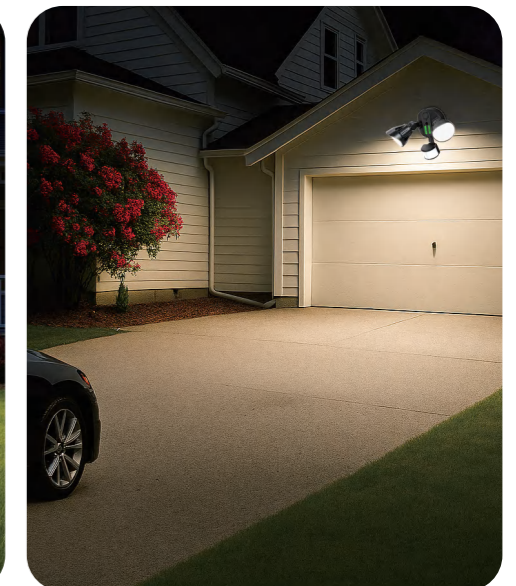
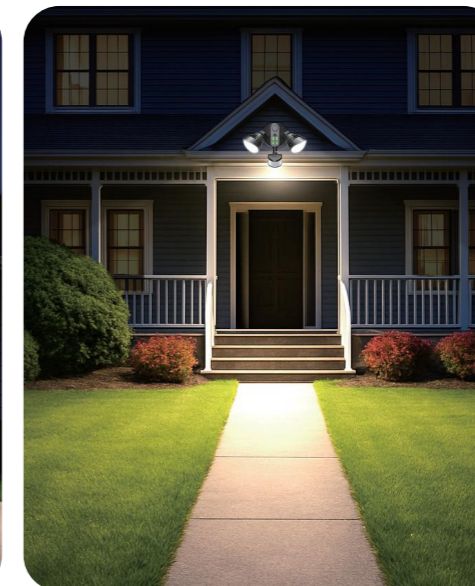

Code SL-LT-JAL812
Wattage 10W/15W/20W
CCT(K) 2700K/3000K/4000K/5000K/6500K
Lumen 2100lm max
Beam Angle 120°
Dimmable Yes
Length 1.2m
Material PC



3 Wattage Tunable

Switch the brightness you need



Interconnectable

Connect the lights for suitable length



Common Shrapnel Buckle

Easy to install or uninstall



T8/5 series

White

5CCT LED Batten Light

T8/5 series		New
Code	SL-LT-JAL812	SL-LT-JAL512
Wattage	10W/15W/20W	10W/14W/18W
CCT(K)	2700K/3000K/4000K/5000K/6500K	3000K/4000K/6500K
Lumen	2100lm max	2000lm max
Beam Angle	120°	120°



Code SL240WT-CCT
Wattage 20W/30W/40W
CCT(K) 2700K/3000K/4000K/5000K/6000K
Lumen 2400lm/3600lm/4800lm
Beam Angle 120°
Dimmable No
Length 1.2m
Material PC



3 Wattage Tunable

Switch the brightness you need

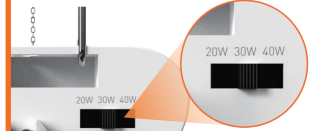

Interconnectable

Connect the lights for suitable length



Self-Locking Design

More stable & safer installation

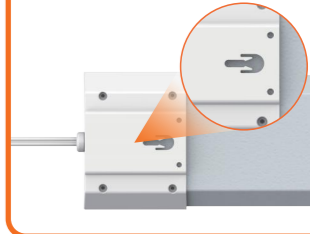

New SL series

White

5CCT LED Shop Light

SL series		New	New
Code	SL240WT-CCT	SLC250WT-CCT	SL260-CTW
Wattage	20W/30W/40W	30W/40W/50W	40W/50W/60W
CCT(K)	2700K/3000K/4000K/5000K/6000K	3000K/4000K/5000K	2700K/3000K/4000K/5000K/6000K
Lumen	2400lm/3600lm/4800lm	3000lm/4000lm/5000lm	3600lm/4500lm/5400lm
Material	PC	PC	PC





SHOP LIGHT



WORK LIGHT

Code SLE260-CTW
 Wattage 30W/45W/60W
 CCT(K) 2700K/3000K/4000K/5000K/6500K
 Lumen 3300lm/4400lm/5500lm
 Beam Angle 220°
 Length 1.2m
 Material PC

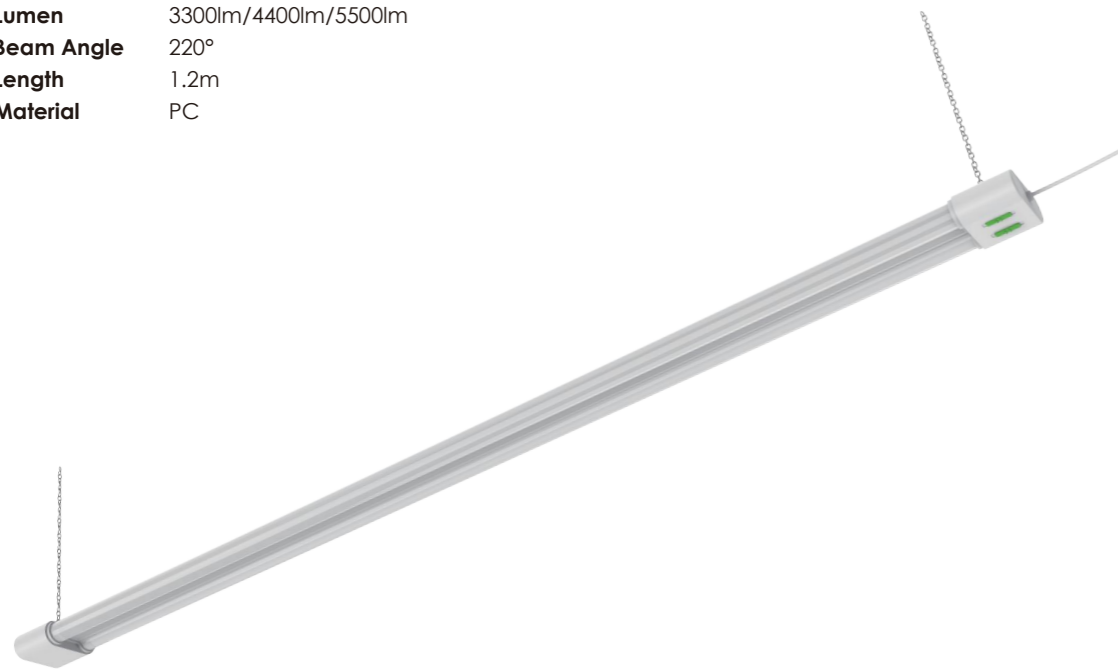

3 Wattage Tunable

Switch the brightness you need



Interconnectable

Connect the lights for suitable length



Omnidirectional Emitting

Brighten up the space & ceiling

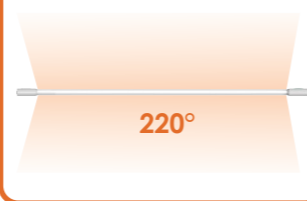

SLE series White

Omnidirectional Emitting LED Shop Light

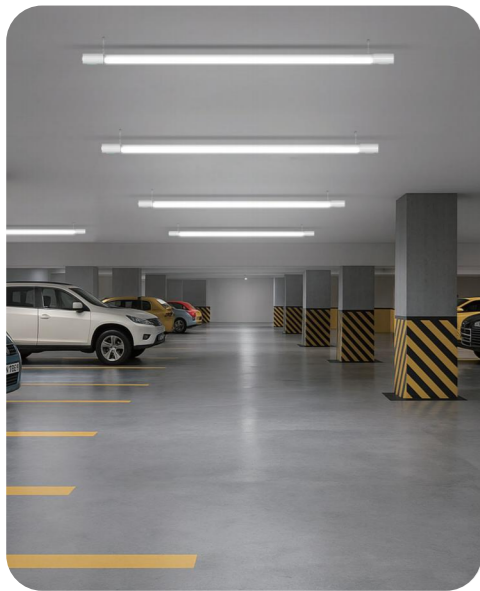

Code SL-K120
 Wattage 30W/40W/50W
 CCT(K) 3000K/4000K/6500K
 Lumen 4500lm/5000lm/5500lm
 Beam Angle 120°
 Length 1.15m
 Material PC



3 Wattage Tunable

Switch the brightness you need



Interconnectable

Connect the lights for suitable length

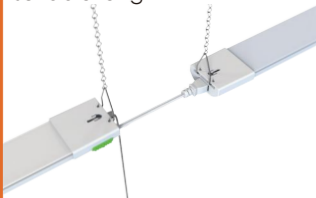

Pull Chain Switch

Pull to control—simple and reliable



K120 series White

3WT + 3CCT LED Batten Light

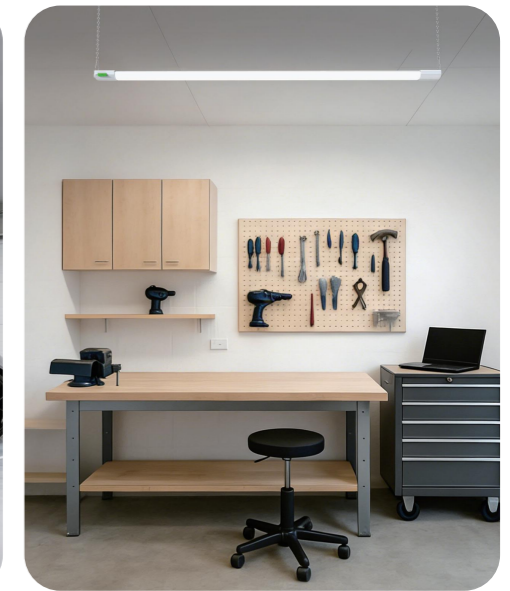



WORK LIGHT

Code FLC36
 Wattage 18W/27W/36W
 CCT(K) 3000K/4000K/6500K
 Lumen 3800lm max
 Input 20VDC tool battery
 Beam Angle 90°/head
 Material ABS



3 Wattage Tunable

Switch the brightness you need



Adjustable Heads

Both horizontal & vertical rotatable



Emergency Power Bank

USB & Type-C charging port



FLC series Black

3CCT Portable LED Floodlight



Wall Light



UB01



UB05



JR20

Cabinet Light



UB02



UB02C



UB03



UB04



UB06

Solar Light



OT-01A



SR03



SAS113



OT-04



OT-05

Coming Soon...



SR260

GLOBAL

Code UB01
 Wattage 3W
 CCT(K) 3000K/4000K/5000K/6000K+RGB
 Lumen 200lm
 Beam Angle 24°
 Dimmable Yes
 Material ABS
 Battery 3.7V 4000mAh
 USB Charging Type-C
 Endurance Time 4.5h



Anti-Glare Design
 Eye protection

Stretch Sheet Available
 Make beam angle bigger

Adjustable Head
 Flexible lighting angle

UB01 series

White

Color Changeable LED Reading Light



Code UB05 (Microwave)
 Wattage 5W
 CCT(K) 3000K/4000K/6000K
 Lumen 320lm
 Beam Angle 0°-70°
 Dimmable Yes
 Material ABS
 Battery 3.7V 4000mAh
 USB Charging Type-C
 Endurance Time 4h
 Detection Range 120°, 8m max (microwave)
 20mm max (hand wave)

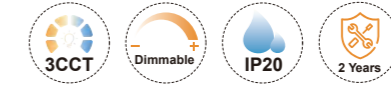

2 Working Modes
 AUTO/HAND WAVE modes available

Beam Angle Adjustable
 Customize the light beam you want

Installation Back Sheet
 No pre-Installation required and easy to remove

UB05 series

White

Black

3CCT Square Wall Light

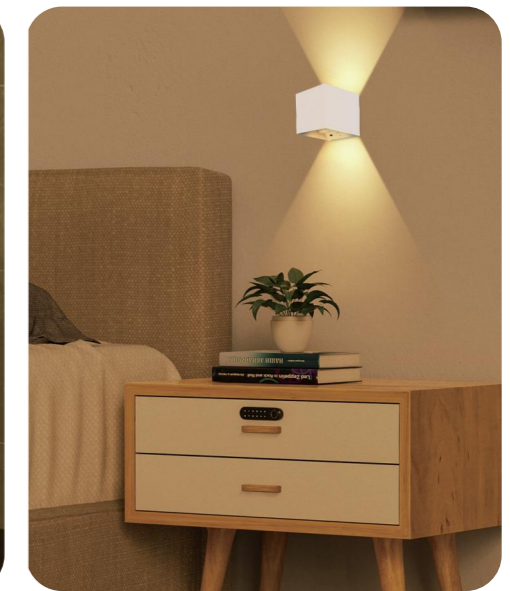

Code JR20
 Wattage 2W
 CCT(K) 2700-6500K
 Lumen 190lm
 Beam Angle 60°
 Dimmable Yes
 Material ABS+AL
 Battery 3.7V 4000mAh
 USB Charging Type-C
 Endurance Time 8h



Retractable & Rotatable

Adaptable to different painting sizes

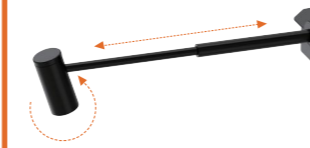

2 Ways for Easy Installation

Magnetic install or rest atop artwork



Ultimate in Convenience

USB rechargeable & remote control



New JR series



Wireless LED Art Light

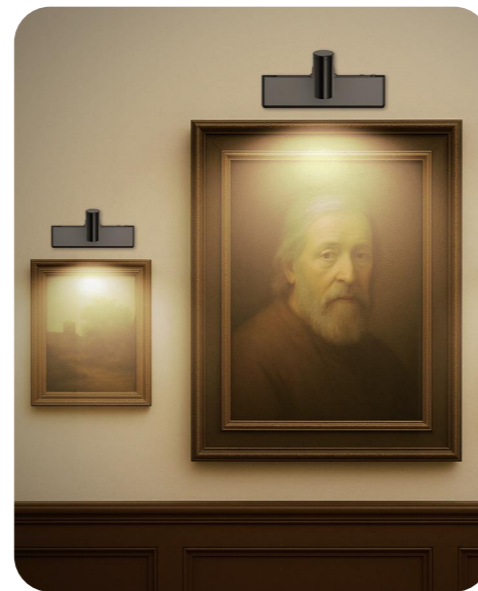

Code UB02-30
 Wattage 1.5W
 CCT(K) 3000K-6000K
 Lumen 120lm
 Beam Angle 120°
 Dimmable Yes
 Material ABS+PC
 Length 30cm
 Battery 3.7V 1500mAh
 USB Charging Type-C
 Endurance Time 6h
 Detection Range 80°, <3m(PIR)
 <10cm(handwave)

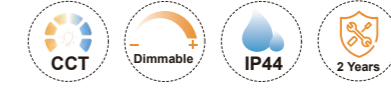

Motion/Wave Sensor

Wide applications in various space



Magnetic Adsorption

Easy to install and get recharged



4 Working Modes



DAY/NIGHT/HAND WAVE/ ON TIME modes available



UB02 series



Wireless Side-Emitting Under Cabinet Bar Light

UB02 series		
Code	UB02-30	UB02-40
Wattage	1.5W	3.5W
Lumen	120lm	220lm
Input	3.7V 1500mAh(Battery)	220-240VAC~50-60Hz
Duration Time	6h	/
Lenth(L)	300mm	400mm





CABINET LIGHT



CABINET LIGHT

Code UB02-C
 Wattage 2.3W
 CCT(K) 3000-6500K
 Lumen 200lm
 Dimmable Yes
 Material ABS
 Lenth 300mm
 Battery 3.7V 1500mAh
 USB Charging Type-C
 Endurance Time 4h



Wireless Connectable
 Convenient group control via remote control



2 Trigger Modes
 Motion/ Handwave sensor activated



Magnetic Adsorption
 Easy to install and get recharged

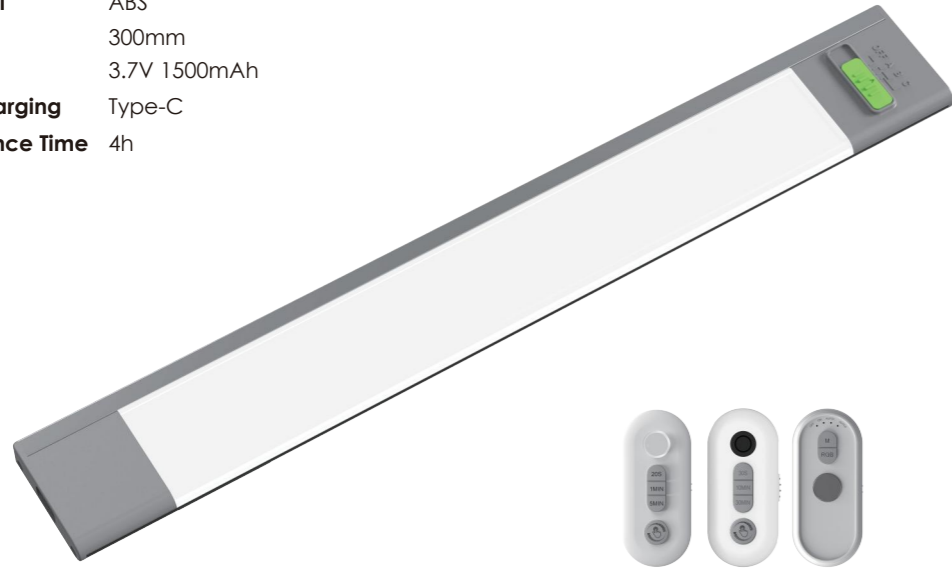

New
UB02C series White

Wireless Connectable Under Cabinet Bar Light



Code UB06R
 Wattage 2W
 CCT(K) 3000K/4000K/6000K+RGB
 Lumen 160-180lm
 Beam Angle 45°/110°
 Dimmable Yes
 Material ABS
 Diameter 85mm
 Battery 3.7V 2000mAh
 USB Charging Type-C
 Endurance Time 6h



Wireless Connectable
 Convenient group control via remote control

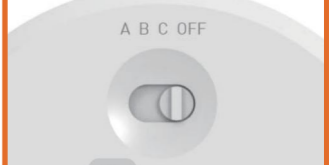

2 Beam Angles Available
 Choose the one more suitable



2 Trigger Modes
 Motion/ Handwave sensor activated



UB06 series White

Wireless Connectable LED Cabinet Light

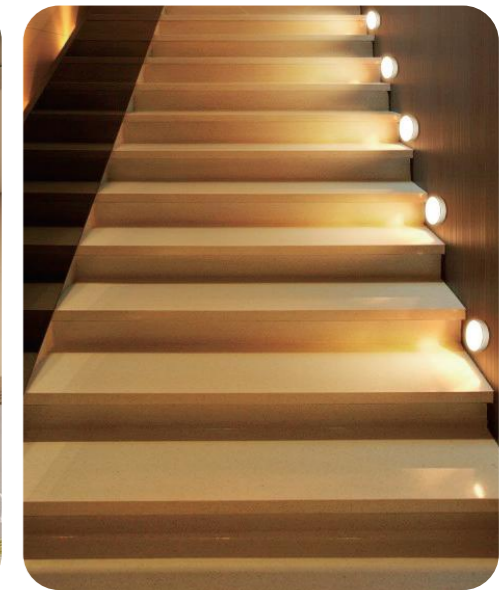

UB | Wireless Surface-Emitting Under Cabinet Bar Light

SPECIFICATIONS

Code	UB03-30	UB03-40	UB03-60
Wattage	1.5W	2W	3W
CCT(K)	3000-6500K		
Lumen	120lm	160lm	240lm
Dimmable	Yes		
Battery	3.7V 1500mAh	3.7V 2000mAh	3.7V 3000mAh
USB Charging	Type-C		
Charging Time	3 hours	4 hours	5 hours
Endurance Time	6 hours		
Working Mode	AUTO/OFF/ON TIME		
Detection Angle	120°		
Sensor Duration Time	30s		
Human Body Detection Distance	0-4m		
Length(L)	30cm	40cm	60cm
Material	ABS+PC		



UB | Side-Emitting Connectable Under Cabinet Bar Light

SPECIFICATIONS

Code	UB04-30	UB04-40	UB04-60
Wattage	5W	6.5W	10W
CCT(K)	3000K-6500K		
Lumen	400lm	520lm	800lm
Dimmable	Yes		
Input	220-240V~50/60Hz		
Output	24V DC		
Working Mode	AUTO/NIGHT/HAND WAVE/ON TIME		
Detection Angle	120°		
Sensor Duration Time	30s/60s/120s		
Human Body Detection Distance	0-4m		
Hand Scan Detection Distance	<10cm		
Length(L)	30cm	40cm	60cm
Material	ABS+PC		

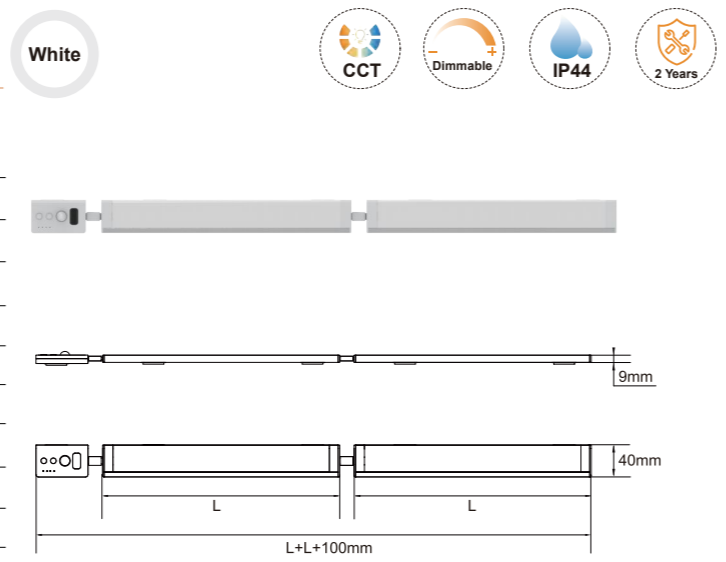

Code	OT-01A-4P3
Wattage	4W
CCT(K)	3000K/4000/6500K
Lumen	180lm
Beam Angle	30°
Dimmable	Yes
Material	ABS+PC
Height	42.6cm
Solar Panel	5.5VDC
Battery	3.7V1800mAh
USB Charging	Type-C
Endurance Time	2.5h
Detection Angle	120°



Adjustable Solar Panel
Efficient solar powered & save energy



Sensitive Motion Sensor
Sensitive Motion Sensor



Adjustable Head
Illuminate specific items you need



OT-01 series Black

30°/120° LED Solar Spike Light

OT series						
Code	OT-01A-1D3	OT-01A-1R	OT-01A-4P3	OT-01B-1D3	OT-01B-1R	OT-01B-4P3
Wattage	2W	1.2W	4W	1.2W	1.2W	4W
Lumen	100lm	60-80lm	180lm	60-80lm	60-80lm	180lm
Illumination	240Lux/1m	240Lux/1m	750Lux/1m	240Lux/1m	240Lux/1m	750Lux
Beam Angle	30°	30°	30°	120°	120°	120°
Detection Angle	/	/	120°	/	/	120°
Endurance Time	8-10h	8-10h	2.5h	8-10h	8-10h	2.5h



Code PL-SR03
 Wattage 1.2W
 CCT(K) 3000K/4000/6500K
 Lumen 75lm
 Dimmable Yes
 Material ABS+PC
 Solar Panel 5VDC
 Battery 3.7V 1500mAh
 USB Charging Type-C
 Endurance Time 12h
 Detection Range 240°,10m max



Wireless Connectable
 Convenient group control



Separated Motion Sensor
 Solar-charged sensor & more flexible sensing distances





4 Working Modes
 DAY/NIGHT/D2D/ON TIME modes available



SR/SAS series



LED Solar Patio Light

SR/SAS series	 New	 New
Code	PL-SR03	PL-SAS113
Wattage	1.2W	1.6W
Lumen	75lm	140lm
CCT(K)	3000K/4000K/6500K	3000K/4000K/6500K
Height	620mm	755mm
Detection Range	240°,10m max	240°,10m max
Endurance Time	12h	12h



OT | Colour Adjustable LED Solar Security Light

SPECIFICATIONS

Code OT-04
 Wattage 5W
 CCT(K) 3000K-6500K
 Lumen 400lm max
 Dimmable Yes
 Beam Angle 100°
 Solar Panel 5.5VDC
 Battery 3.7V 1800mAh
 Charging Time 8-10 hours by solar energy
 USB Charging 3.5 hours by Type-C
 Endurance Time 2 hours
 Working Mode AUTO/D2D/ON TIME
 Detection Angle 120°
 Sensor Duration Time 30s/60s/120s
 Detection Distance 9m max
 Material ABS+PC

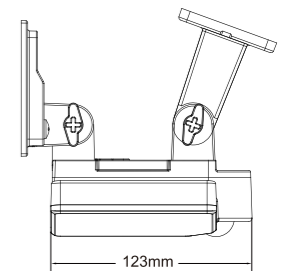
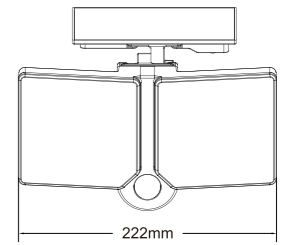

OT | Colour Adjustable LED Solar Security Light

SPECIFICATIONS

Code OT-05
 Wattage 5W
 CCT(K) 3000K/4000K/6500K
 Lumen 400lm
 Dimmable No
 Beam Angle 100°
 Solar Panel 5.5VDC
 Battery 3.7V 1800mAh
 Charging Time 8-10 hours by solar energy
 USB Charging 3.5 hours by Type-C
 Endurance Time 2 hours
 Detection Brightness 5-2000Lux
 Detection Angle 120°
 Sensor Duration Time 3secs-8mins
 Detection Distance 16m max
 Material ABS+PC

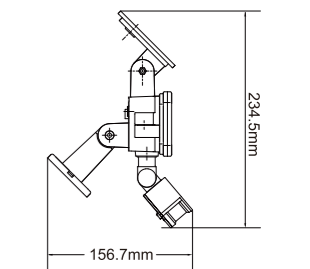
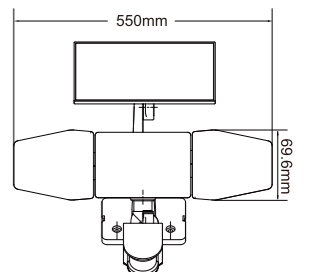

Coming Soon...



SR260 Wall Light

- ★ Bidirectional Lighting
- ★ Rotatable Head